

# WYLELA COVE DETAIL SHEET - 06-16-23 - REVISION 01

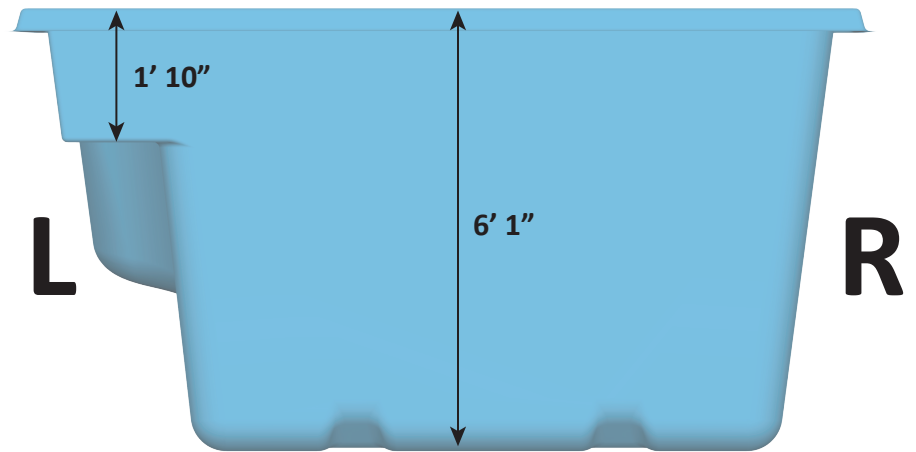

**USA Specifications**

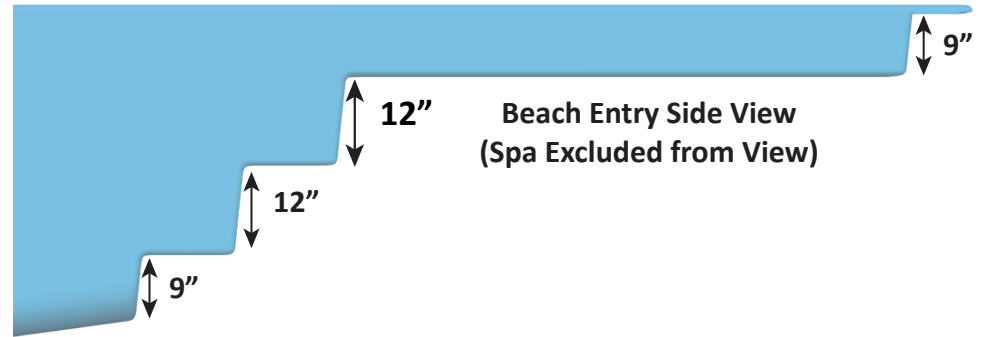
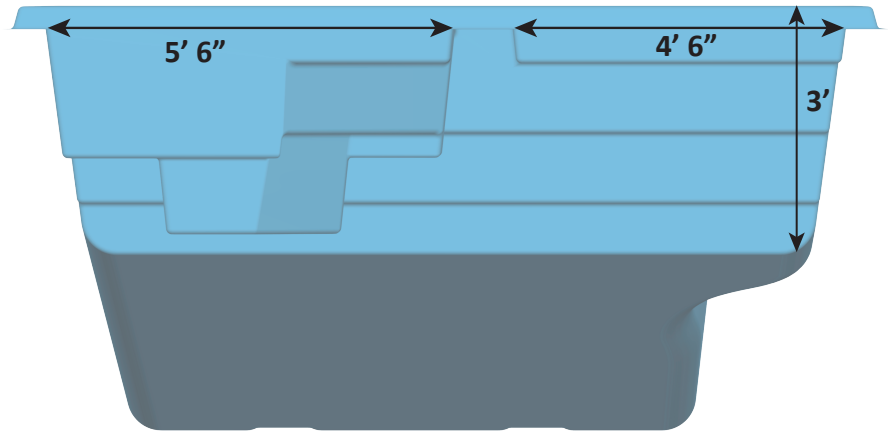
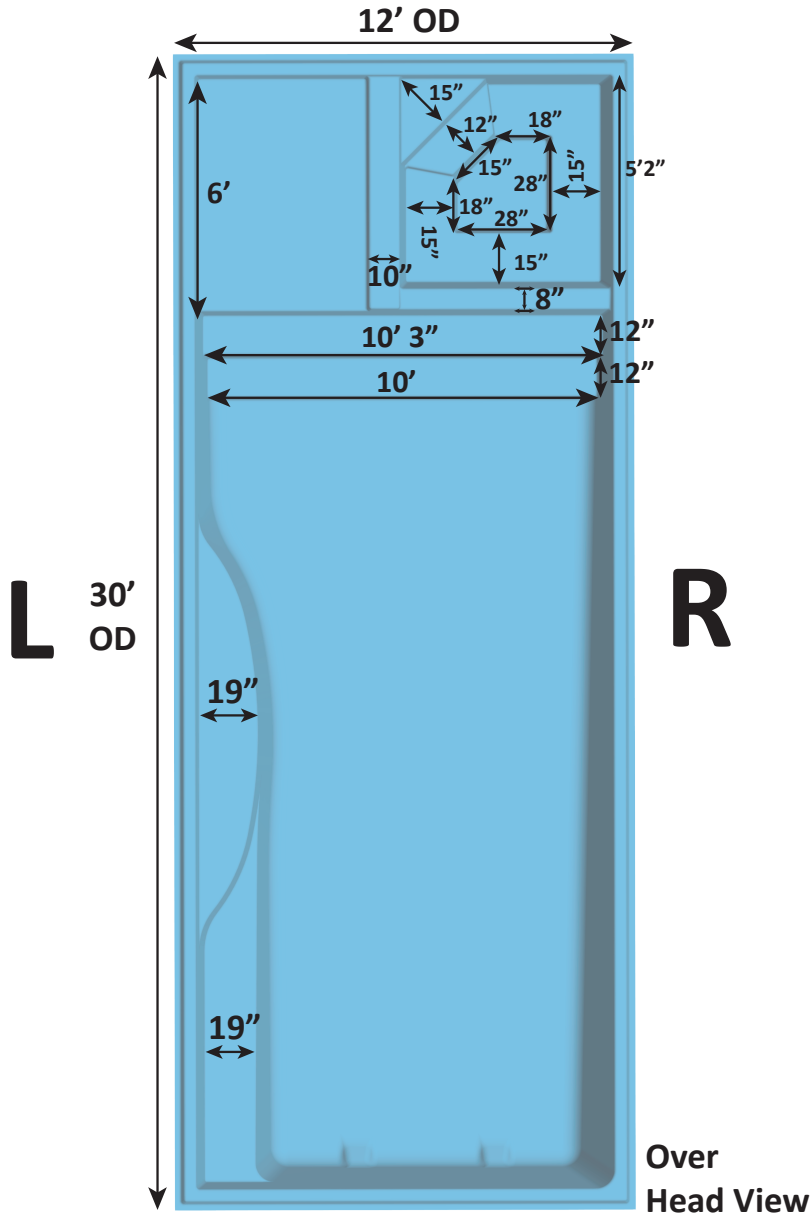

Total Surface Area: 319 Sq. ft.  
 Total Perimeter: 80 Lin. ft.  
 Total Volume: 7, 829 Gal. Spa  
 Surface Area: 31 Sq. ft. Spa  
 Perimeter: 23 Lin. ft. Spa  
 Volume: 445 Gal. Beach  
 Surface Area: 28 Sq. ft.



Per sect. 8.1, surfaces that provide footing have slip resistant surfaces. All measurements are averages.

# WYLELA COVE DETAIL SHEET - 06-16-23 - REVISION 01

## KEY

RC = RIGHT CORNER

LC = LEFT CORNER

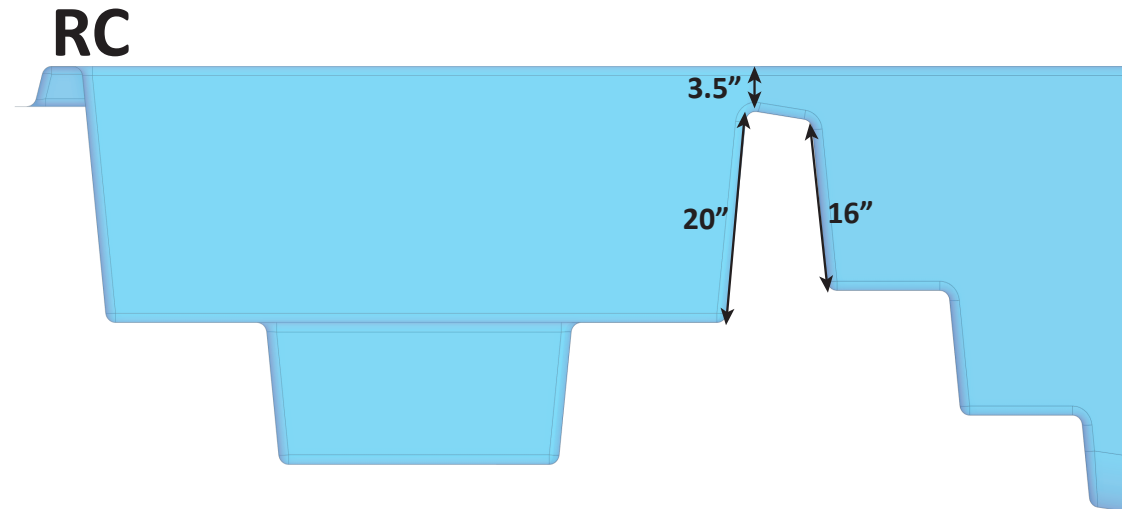
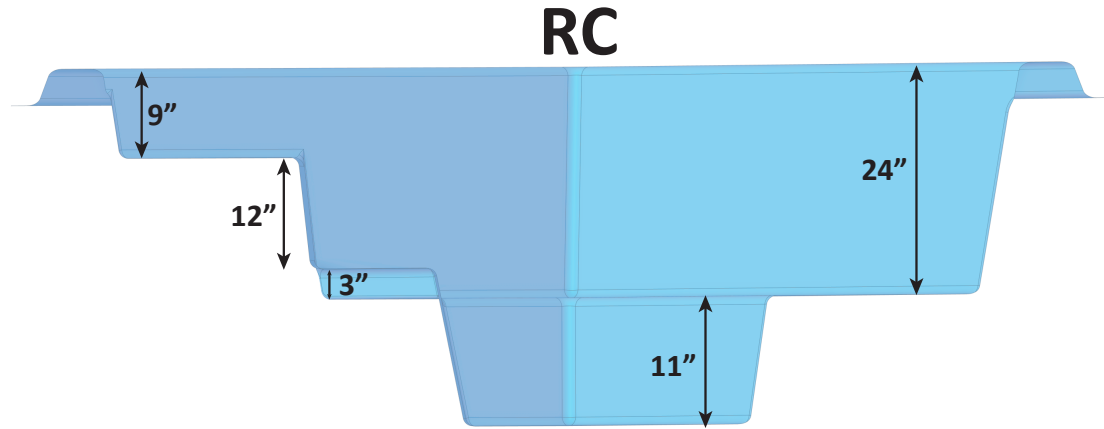
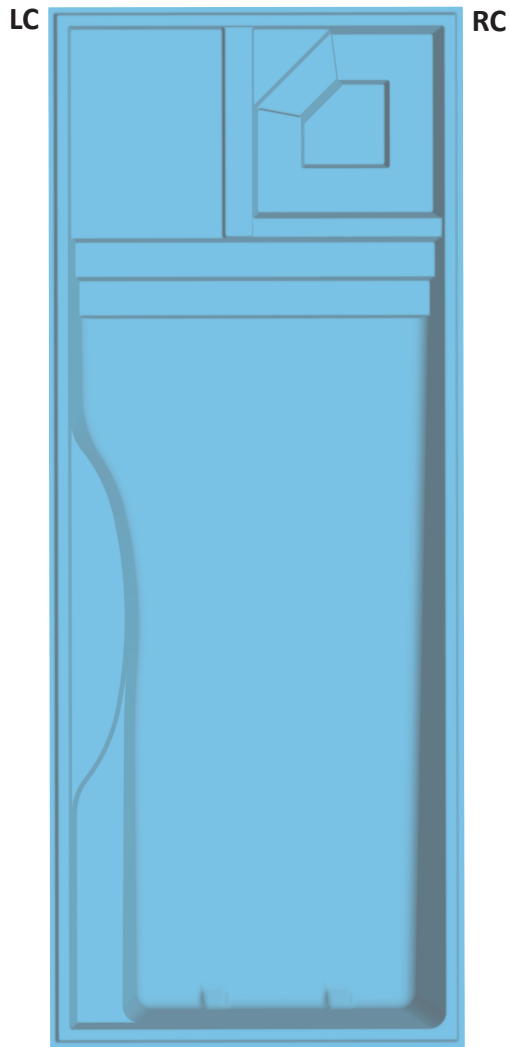

Total Surface Area: 319 Sq. ft.

Total Perimeter: 80 Lin. ft.

Total Volume: 7,829 Gal.

Spa Surface Area: 31 Sq. ft.

Spa Perimeter: 23 Lin. ft.

Spa Volume: 445 Gal.

Beach Surface Area: 28 Sq. ft.

USA Specifications



Per sect. 8.1, surfaces that provide footing have slip resistant surfaces. All measurements are averages.

# WYLELA COVE DETAIL SHEET - 06-16-23 - REVISION 01

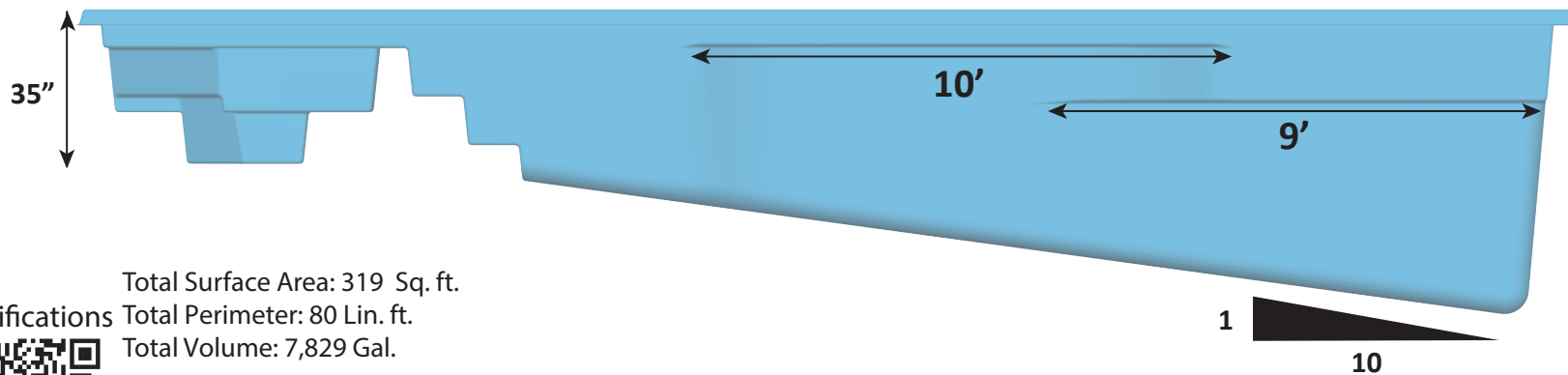
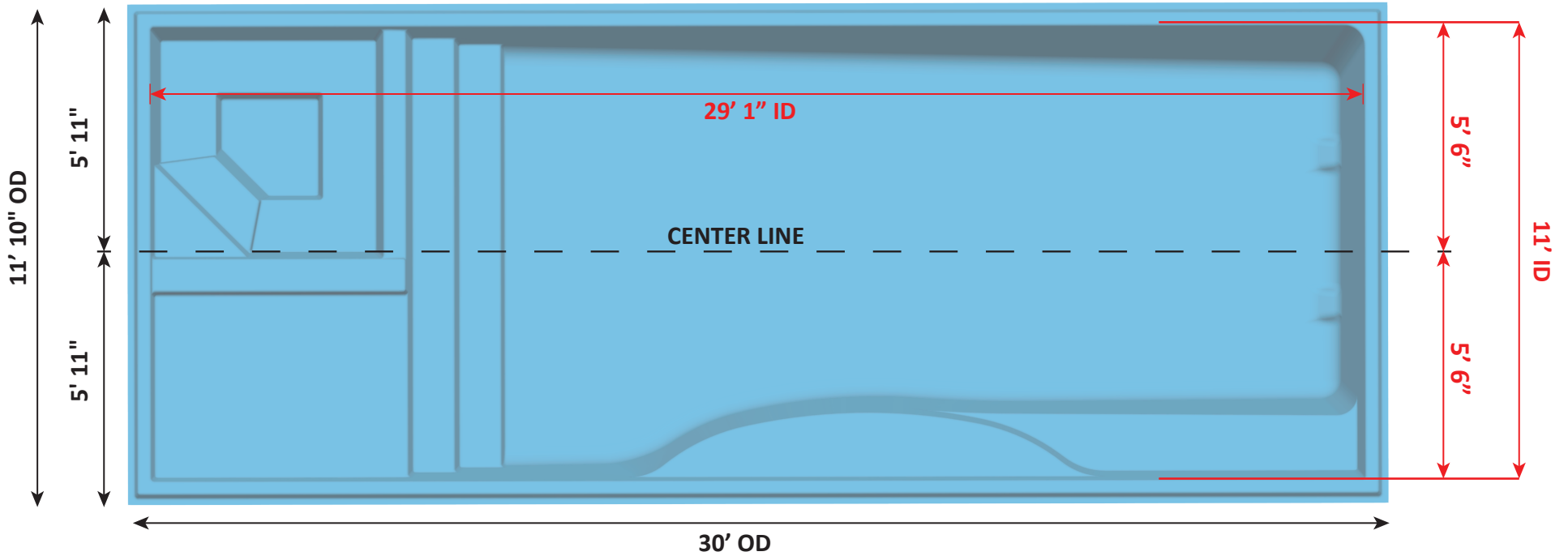

USA Specifications



Total Surface Area: 319 Sq. ft.  
 Total Perimeter: 80 Lin. ft.  
 Total Volume: 7,829 Gal.

Spa Surface Area: 31 Sq. ft.  
 Spa Perimeter: 23 Lin. ft.  
 Spa Volume: 445 Gal.

Beach Surface Area: 28 Sq. ft.



Per sect. 8.1, surfaces that provide footing have slip resistant surfaces. All measurements are averages.