

LAKE SUPERIOR DETAIL SHEET - 10-28-21 - REVISION 02

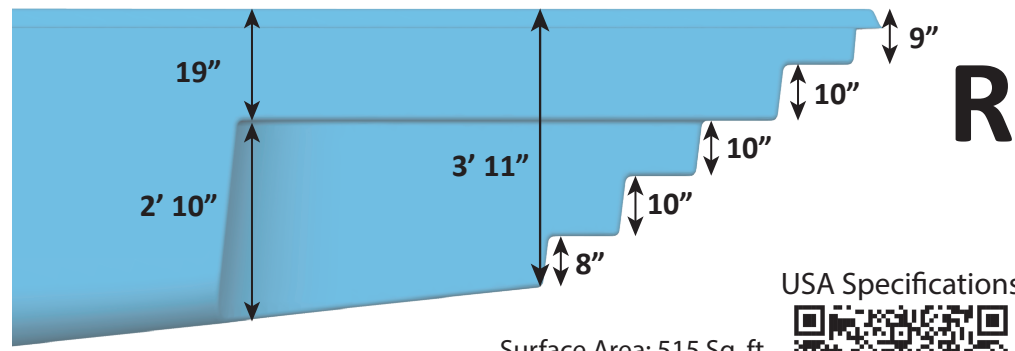

Surface Area: 515 Sq. ft.
 Perimeter: 92 Lin. ft.
 Volume: 14,601 Gal.
 Per sect. 8.1, surfaces that provide footing have slip resistant surfaces.
 All measurments are averages.

USA Specifications

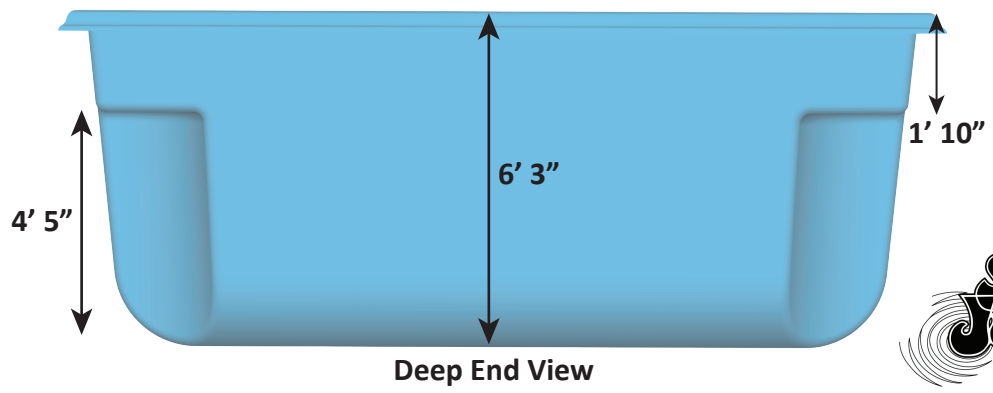
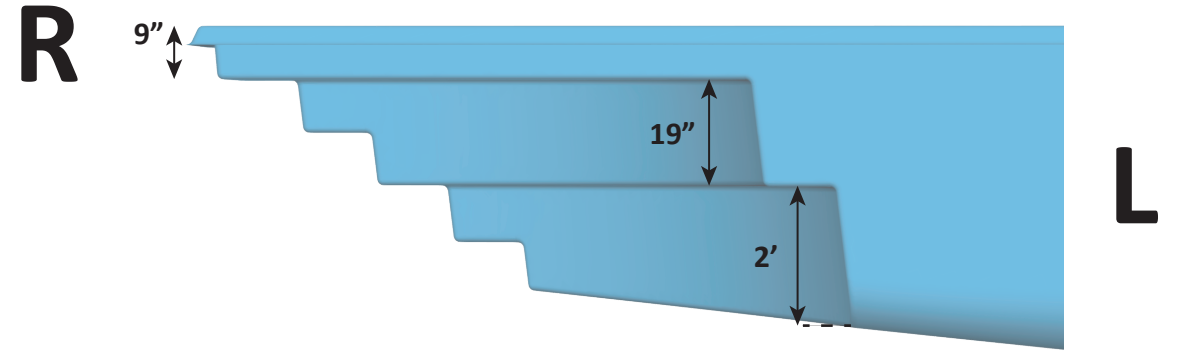
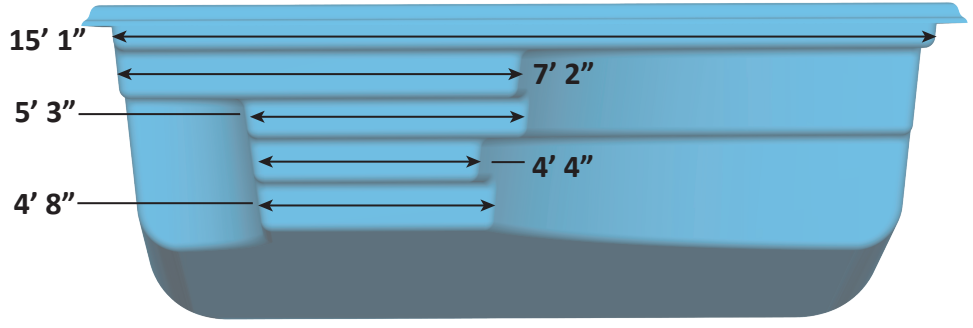
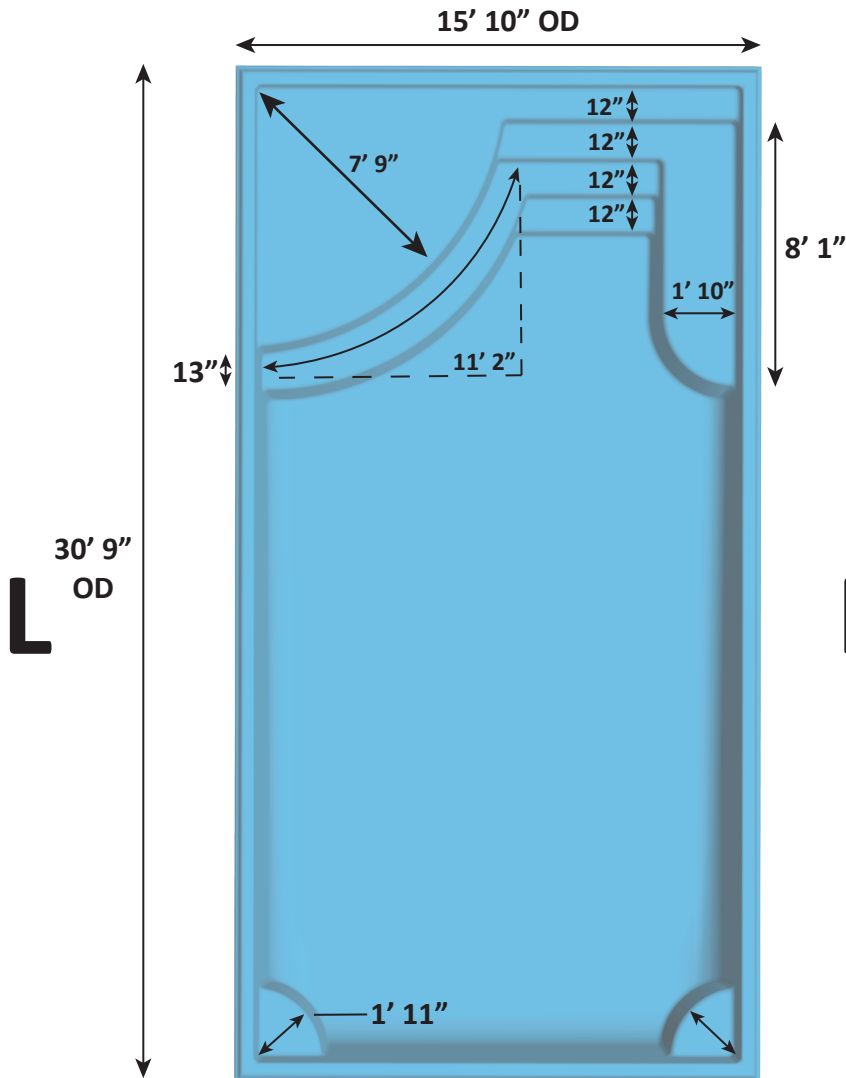

LAKE SUPERIOR DETAIL SHEET - 10-28-21 - REVISION 02

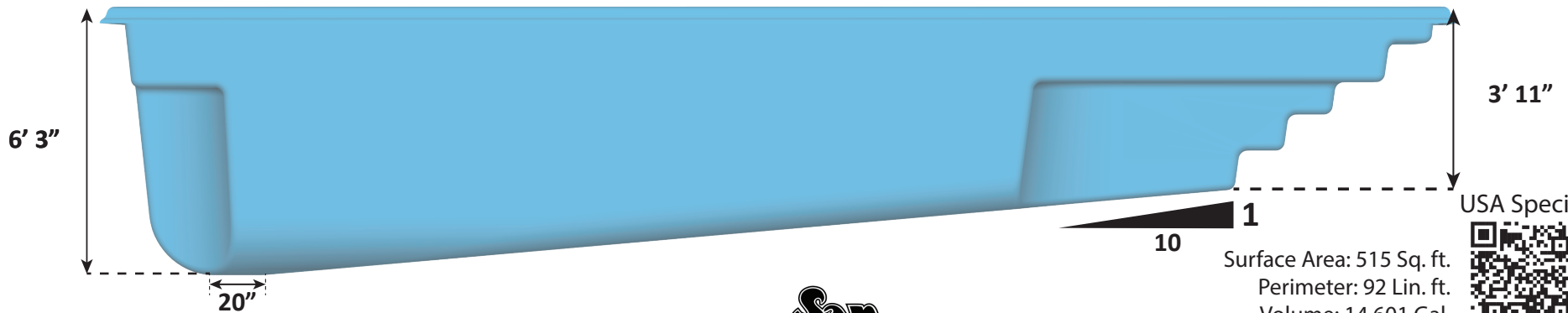
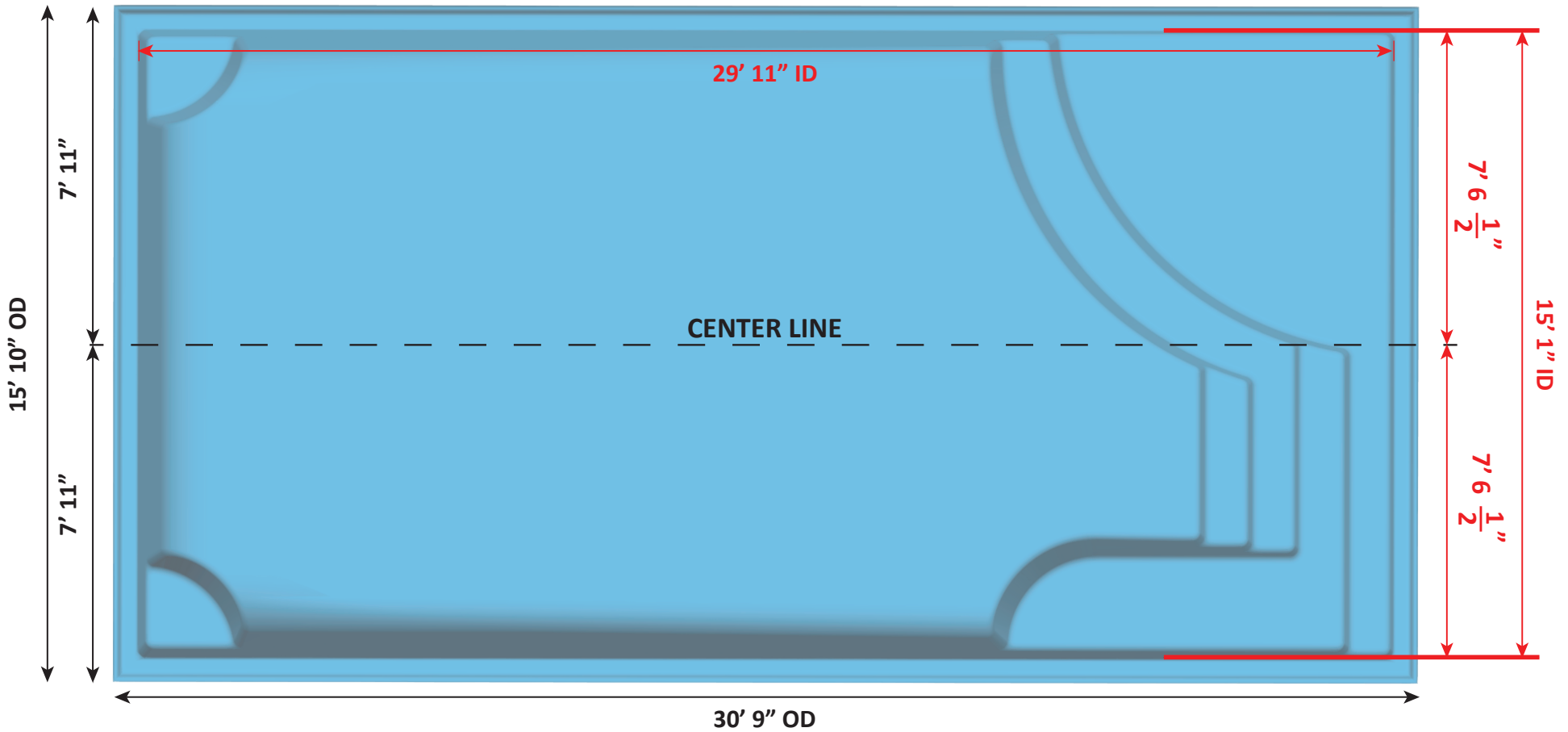

USA Specifications



Surface Area: 515 Sq. ft.
 Perimeter: 92 Lin. ft.
 Volume: 14,601 Gal.
 Per sect. 8.1, surfaces that provide
 footing have slip resistant surfaces.
 All measurements are averages.

