

Surface Area: 300 Sq ft  
 Perimeter: 82 Lin. ft  
 Total Volume: 7,410 Gal.  
 Spa Volume: 411 Gal.  
 Per sect. 8.1, surfaces that provide  
 footing have slip resistant surfaces.  
 All measurements are averages.

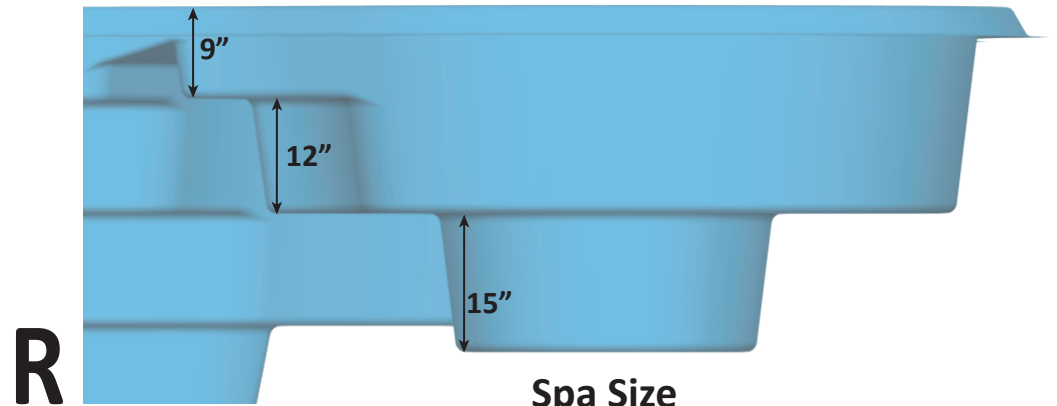

USA Specifications

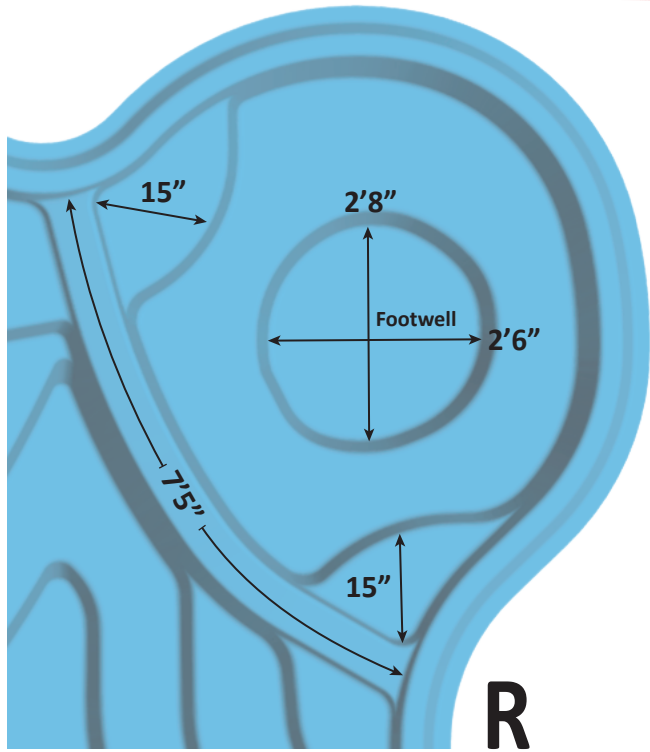

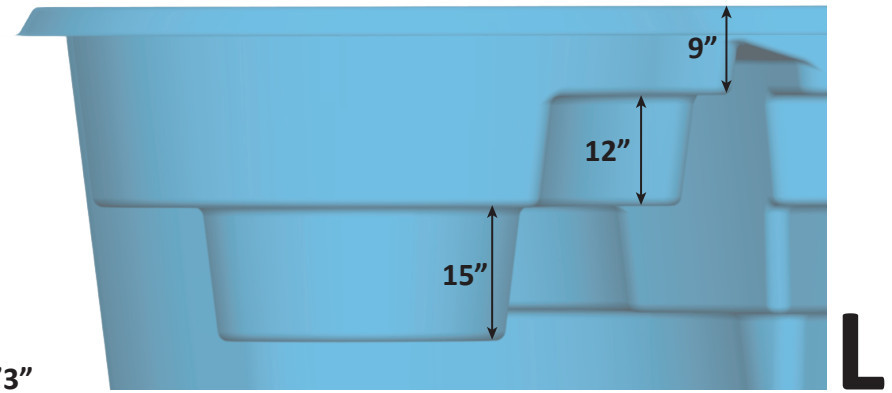
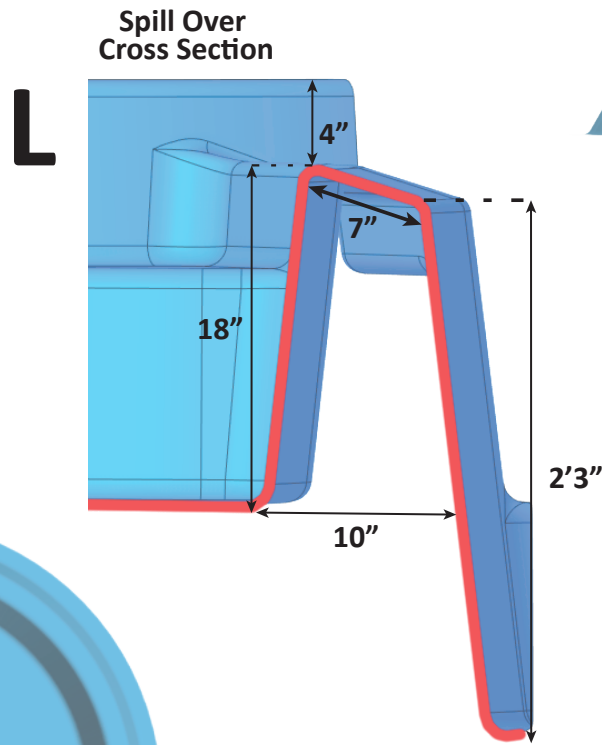
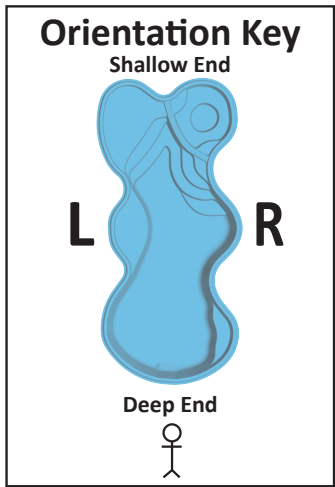

**Spa Size**  
**6 FT x 7FT x 3FT**

Surface Area: 300 Sq ft  
Perimeter: 82 Lin. ft  
Total Volume: 7,410 Gal.  
Spa Volume: 411 Gal.  
Per sect. 8.1, surfaces that provide footing have slip resistant surfaces.  
All measurments are averages.



USA Specifications



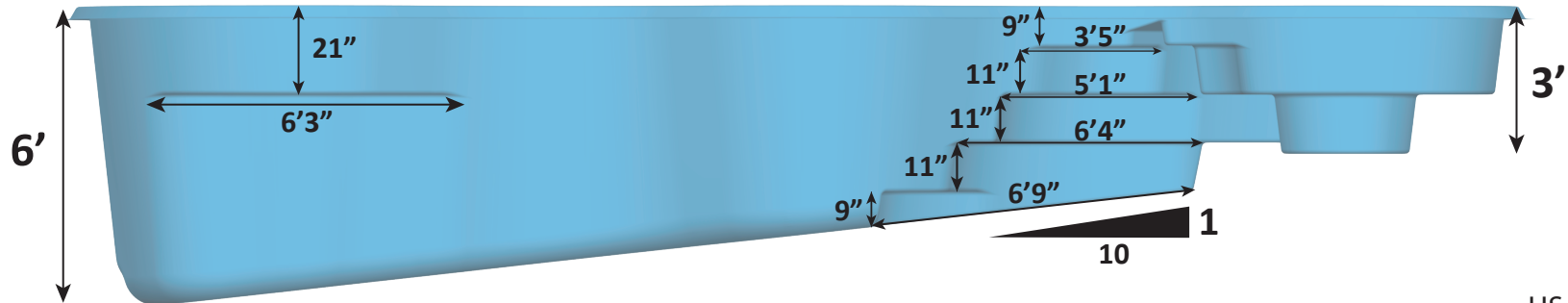
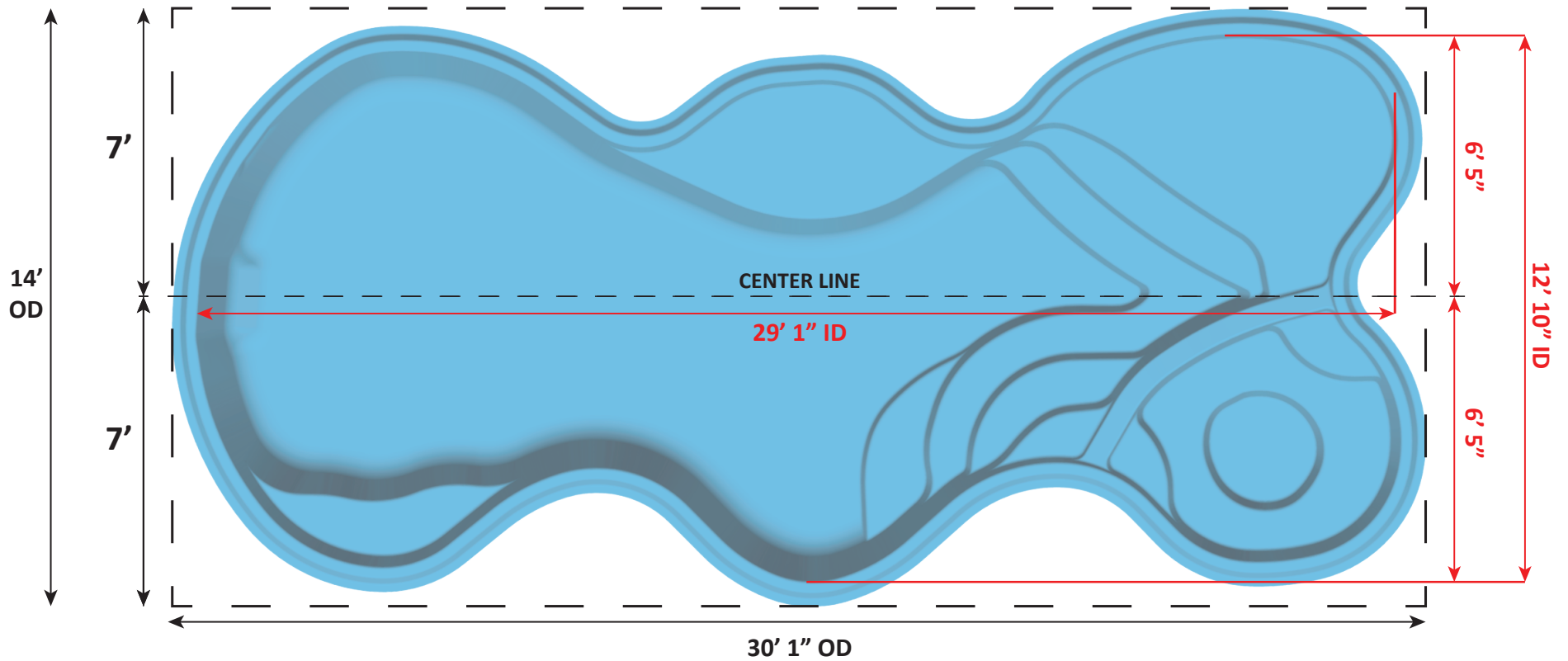

Surface Area: 300 Sq ft  
 Perimeter: 82 Lin. ft  
 Total Volume: 7,410 Gal.  
 Spa Volume: 411 Gal.  
 Per sect. 8.1, surfaces that provide  
 footing have slip resistant surfaces.  
 All measurments are averages.



USA Specifications

